



Remote Meter

User Manual



MT11

Contents

1. Important Safety Instructions	1
2. Overview	2
3. Product Classification	3
4. Installation	4
4.1 MT11 base (Optional accessory)	4
4.2 Wall Installation	5
4.3 Surface Installation	6
5. Product Features	8
5.1 Front View	8
5.2 Rear View	10
6. Display and operation	12
6.1 LCD	12
6.2 Auto Global-View Mode	14
6.3 Temperature Units	15
6.4 Clear the Generated Energy	15
6.5 Battery Type	16
6.6 Fault Indication	21
7. Specifications	22
8. Warranty	23

1. Important Safety Instructions

Thank you for selecting the MT11 remote meter.

General safety information

- Please contact our company or transportation if the product has been damaged.
- Please read this manual carefully before using the product and pay attention to the safety information.
- Do not install the remote meter in humid, salt spray, corrosion, greasy, flammable, explosive, dust accumulative, or other severe environments.
- Keep the product away from rain, exposure, severe dust, vibrations, corrosive gas, and intense electromagnetic interference.
- Do not allow water to enter the product.
- There are no serviceable parts inside the product. Do not disassemble or attempt to repair it.

Recommendations

- The MT11 is only allowed to connect with the DR-N series charge controller. Please confirm before purchase and installation.
- Do not install MT11 in a strong electromagnetic situation.

2. Overview

The MT11 remote meter, matching the DuoRacer series controllers, can monitor the controller's running data and working status.

Features:

- Easy to install and operate
- Real-time display of fault alarms
- Locally readable real-time parameters
- Powered by the controller directly

3. Product Classification

1) MT11(including the 1.5m communication cable)

- + Remote meter MT11
- + 1.5m communication cable (Model: CC-RS485-RS485-3.81-4P-150)
- + Base of MT11

2) MT11 (including the 5m communication cable)

- + Remote meter MT11
- + 5m communication cable (Model: CC-RS485-RS485-3.81-4P-500)
- + Base of MT11

3) MT11 (including the 10m communication cable)

- + Remote meter MT11
- + 10m communication cable (Model: CC-RS485-RS485-3.81-4P-1000)
- + Base of MT11

4) MT11(Do not include the communication cable)

- + Remote meter MT11
- + 1.5m communication cable (Model: CC-RS485-RS485-3.81-4P-150)
- + Do not include the MT11 base

NOTE: The customers can purchase the product according to the requirement.

4. Installation

4.1 MT11 base (Optional accessory)

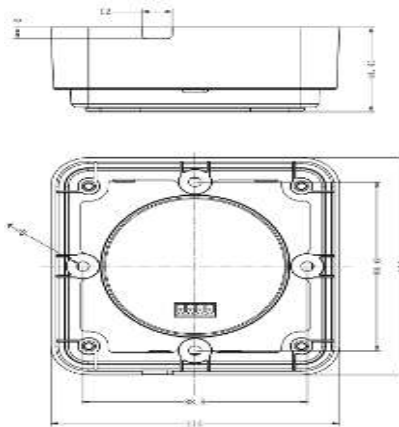

Mechanical parameter	Parameter
Dimension	114mm x 114mm x 44.41mm
Mounting size	88.6mm x 88.6mm
Mounting hole size	Φ5mm

4.2 Wall Installation

Step1: Locate and drill screw holes based on the Frame Mounting dimension of the base, and erect the plastic expansion bolts.

Step2: Use four PA4.2×32 self-tapping screws to fix the Frame.

Step3: Remove the decorative shell.

Step4: Use four M4×8 pan head screws to mount the MT11 surface on the Frame.

Step5: Install the decorative shell.



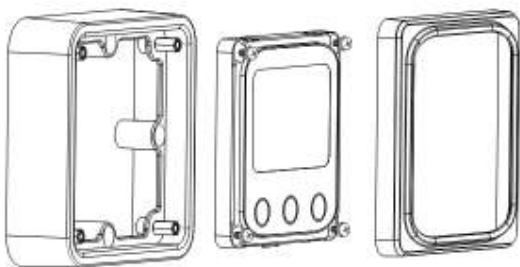

4.3 Surface Installation



Step1: Locate and drill screw holes based on the installation size of the surface.

Step2: Remove the decorative shell.

Step3: Use four M4×8 cross-recessed pan head screws with M4 nuts to mount the MT11 surface onto the panel.

Step4: Install the decorative shell.

NOTE: Take full consideration of the plugging/unplugging space of the communication cable and the cable length during installation.

5. Product Features

5.1 Front View

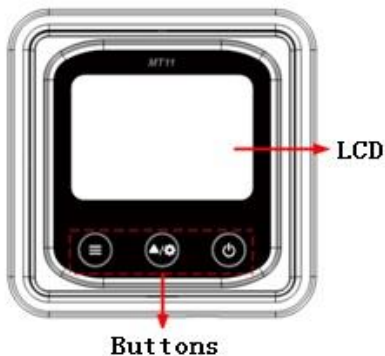



- **LCD screen**

Man-machine interaction operation interface. Refer to chapter 6, *Display and operation*.

- **Buttons**

The meter buttons include two function buttons and one switch button.

	<p>Press the button</p>	<p>1. PV array parameters 2. Storage battery parameters 3. Browse the start battery parameters automatically (Auto)</p>
	<p>Press the button</p>	<p>Browse the PV array parameters Browse the Storage battery parameters Browse the start battery parameters</p>
	<p>Press the button and hold on 5s</p>	<p>Temperature units Battery type</p>
	<p>Press the button</p>	<p>The meter is powered ON</p>
	<p>Press the button and hold on 5s</p>	<p>The meter is powered OFF</p>

5.2 Rear View

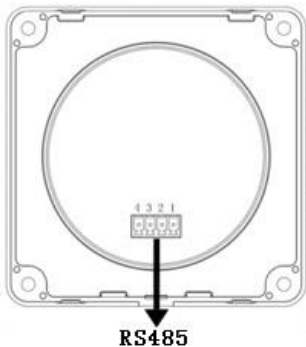

- **RS485 communication port**

It is used to connect the controller to supply power to the MT11.

- **Communication cable's models**

CC-RS485-RS485-3.81-4P-150(Included)

CC-RS485-RS485-3.81-4P-1000(Optional)

CC-RS485-RS485-3.81-4P-2000(Optional)

■ Pins definition

PIN	Definition
1	DC5V
2	RS485-B
3	RS485-A
4	GND

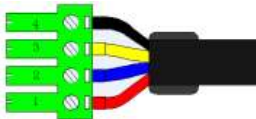























6. Display and operation

6.1 LCD



Note: The display screen can be viewed clearly when the angle between the end-users horizontal sight and the display screen is within 90°. If the angle exceeds 90°, the information on the display screen cannot be viewed clearly.

Icon	Instruction	Icon	Instruction
	BATT1 battery capacity level ⁰ ~12%		BATT2 battery capacity level ⁰ ~12%
	BATT1 battery capacity level ¹³ ~35%		BATT2 battery capacity level ¹³ ~35%
	BATT1 battery capacity level ³⁶ ~61%		BATT2 battery capacity level ³⁶ ~61%

 Main	BATT1battery capacity level①62%~86%	 Start	BATT2battery capacity level①62%~86%
 Main	BATT1battery capacity level①87%~100%	 Start	BATT2battery capacity level①87%~100%
	Day		PV array
	Night		BATT1 charging icon
	Display the parameters of PV		BATT2charging icon
	Display the parameters of BATT1		BATT1temperature parameters
	Display the parameters of BATT2	AES	AES signal icon
	Setting icon	Batt.Type	Battery type icon
	Auto global view sign	Min.	Minimum voltage icon
	Fault Icon	Max.	Maximum voltage icon

① Battery power capacity is calculated by the linear relationship between the low voltage disconnect voltage and float charging voltage disconnect voltage.

6.2 Auto Global-View Mode

Step1: Press the  button, *Auto* is appear.

Step2: Press the  button and select the .

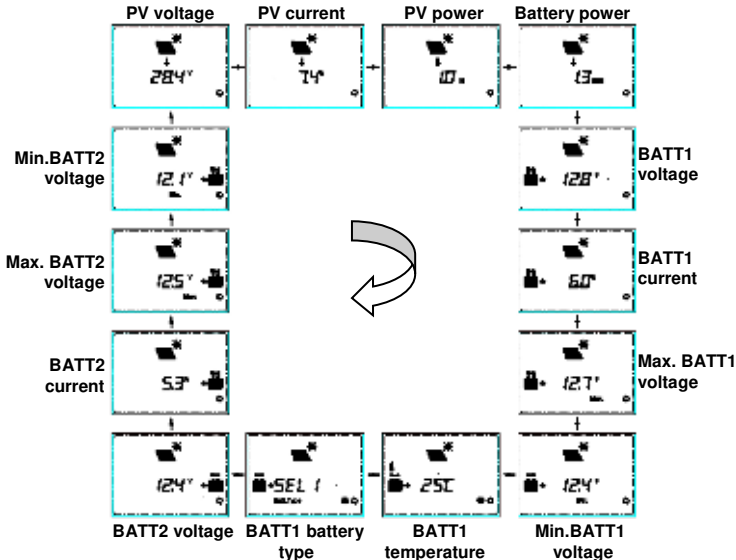

6.3 Temperature Units





Step1: Press the  button under the battery temperature interface.

Step2: Press the  button to select the temperature unit.

Step3: Press the  button to set successfully.

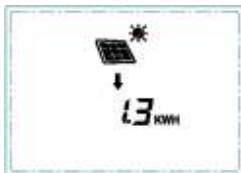
6.4 Clear the Generated Energy





Press the  and  button for 5s to clear the generated energy.

6.5 Battery Type



1) Operation:

Step1: Press the  button and hold 5s under the battery type interface.

Step2: Press the  button when the battery type interface is flashing.

Step3: Press the  button to confirm the battery type.

2) Battery type

<i>SEL 1</i>	BATT112V Sealed	<i>SEL 2</i>	BATT124V Sealed
<i>GEL 1</i>	BATT112V Gel	<i>GEL 2</i>	BATT124V Gel
<i>FLd 1</i>	BATT112V Flooded	<i>FLd 2</i>	BATT124V Flooded
<i>LIF4</i>	LiFePO ₄ (4S)	<i>LIF8</i>	LiFePO ₄ (8S)
<i>LIC3</i>	Li-NiCoMn (3S)	<i>LIC6</i>	Li-NiCoMn (6S)
<i>USE</i>	User		



CAUTION: The voltage parameters cannot be modified when selecting the default battery type. Please switch to the "User" battery type to modify the voltage parameters.



CAUTION: Modify the voltage parameters via the PC software. The MT11 can set the battery type while not modifying the voltage parameters.

3) Lead-acid Battery Control Voltage Parameters

The parameters are in the 12V system at 25 °C. Please double the values in the 24V system.

Battery type Voltage parameter	Sealed	Gel	Flooded	User
Over Voltage Disconnect Voltage	16.0V	16.0V	16.0V	9~17V
Charging Limit Voltage	15.0V	15.0V	15.0V	9~17V
Over Voltage Reconnect Voltage	15.0V	15.0V	15.0V	9~17V
Equalize Charging Voltage	14.6V	—	14.8V	9~17V
Boost Charging Voltage	14.4V	14.2V	14.6V	9~17V
Float Charging Voltage	13.8V	13.8V	13.8V	9~17V
Boost Voltage Reconnect Voltage	13.2V	13.2V	13.2V	9~17V
Low Voltage Reconnect Voltage	12.6V	12.6V	12.6V	9~17V
Under Voltage Reconnect Voltage	12.2V	12.2V	12.2V	9~17V

Battery type Voltage parameter	Sealed	Gel	Flooded	User
Under Voltage Warning Voltage	12.0V	12.0V	12.0V	9~17V
Low Voltage Disconnect Voltage	11.1V	11.1V	11.1V	9~17V
Discharge Voltage Limit Voltage	10.6V	10.6V	10.6V	9~17V
Equalize Duration (minute)	120	—	120	0~180
Boost Duration (minute)	120	120	120	10~180

NOTE:

- When the battery type is sealed, gel, or flooded, the adjusting range of equalizing duration is 0 to 180 minutes, and boost duration is 10 to 180 minutes.
- The following rules must be observed when modifying the value of the parameter in user battery type (factory default value is the same as sealed type):
 - A. Over Voltage Disconnect Voltage > Charge Voltage Limit Voltage ≥ Equalize Charging Voltage ≥ Boost Charging Voltage ≥ Float Charging Voltage > Boost Voltage Reconnect Voltage
 - B. Over Voltage Disconnect Voltage > Over Voltage Reconnect Voltage
 - C. Low Voltage Reconnect Voltage > Low Voltage Disconnect Voltage ≥ Discharge Voltage Limit Voltage

- D. Under Voltage Reconnect Voltage > Under Voltage Warning Voltage ≥ Discharge Voltage Limit Voltage
- E. Boost Voltage Reconnect Voltage > Low Voltage Disconnect Voltage

4) Lithium Battery Control Voltage Parameters

The parameters are in the 12V system at 25 °C; please double the values in the 24V system.

Battery type Voltage parameter	LiFePO ₄ (4S)	Li-NiCoMn (3S)	User
Over Voltage Disconnect Voltage	15.6V	13.5V	9~17V
Charge Voltage Limit Voltage	14.6V	12.6V	9~17V
Over Voltage Reconnect Voltage	14.5V	12.5V	9~17V
Equalize Charging Voltage	14.5V	12.5V	9~17V
Boost Charging Voltage	14.5V	12.5V	9~17V
Float Charging Voltage	13.8V	12.2V	9~17V
Boost Voltage Reconnect Voltage	13.2V	12.1V	9~17V
Low Voltage Reconnect Voltage	12.4V	10.5V	9~17V
Under Voltage Reconnect Voltage	12.5V	11.0V	9~17V
Under Voltage Warning Voltage	12.0V	10.5V	9~17V
Low Voltage Disconnect Voltage	11.0V	9.3V	9~17V
Discharge Voltage Limit Voltage	10.8V	9.3V	9~17V

The following rules must be observed when modifying the parameter values in User for the lithium battery.

- A. Over Voltage Disconnect Voltage > Over Charge Protection Voltage (Protection Circuit Modules(BMS))+0.2V
- B. Over Voltage Disconnect Voltage > Over Voltage Reconnect Voltage = Charge Voltage Limit Voltage ≥ Equalize Charging Voltage = Boost Charging Voltage ≥ Float Charging Voltage > Boost Voltage Reconnect Voltage
- C. Low Voltage Reconnect Voltage > Low Voltage Disconnect Voltage ≥ Discharge Voltage Limit Voltage
- D. Under Voltage Reconnect Voltage > Under Voltage Warning Voltage ≥ Discharge Voltage Limit Voltage
- E. Boost Voltage Reconnect Voltage > Low Voltage Reconnect Voltage
- F. Low Voltage Disconnect Voltage ≥ Over Discharge Protection Voltage (BMS)+0.2V







WARNING: The lithium battery voltage parameters must be set according to the voltage parameters of the lithium battery BMS.



WARNING: The required accuracy of BMS shall be at least 0.2V. If the deviation exceeds 0.2V, the manufacturer will assume no liability for any system malfunction caused by this.

6.6 Fault Indication

Fault	LCD	Instruction
BATT2 overvoltage		Full battery level, the battery frame, and fault icon blink.
BATT2 over-discharged		Empty battery level, the battery frame, and fault icon blink.
BATT2 over temperature		Real battery level, the battery frame, fault icon, temperature icon, temperature value, and the temperature unit blink.
BATT2 system voltage level error ^①		Empty battery level, the battery frame, and fault icon blink.
No battery connection, just PV connects		The BATT2, BATT1, and the fault icon blink simultaneously.

- ① There is No system voltage level error when adopting the Lithium batteries for BATT2.

7. Specifications

Model	MT11
Apply to model	DRN series
Self-consumption(Power on)	13mA/5Vdc
Self-consumption(Power off)	4mA
Communication way	RS485
Communication port	3.81-4P
RS485 cable	CC-RS485-RS485-3.81-4P-150(1.5m) CC-RS485-RS485-3.81-4P-500(5m) CC-RS485-RS485-3.81-4P-1000(10m)
Environment temperature	-20°C~+70°C
Storage temperature range	-20°C~+70°C
Enclosure	IP20
Dimension	98.4×98.4mm
Base cover dimension	114×114mm
Net Weight	0.11kg

8. Warranty

Before maintenance, check the product by the user manual or the after-sales personnel to determine the problem. If it is necessary to return to the factory for maintenance, please express the product to our company, prepay the freight and provide the ticket related to the purchase.

The returned product must be marked with the model, working environment, and fault description for the quick repair guarantee. This information is important to resolve the problems quickly.

We are not responsible for damage to the product caused by improper usage or failure to follow this user manual!

The maintenance is carried out regarding the above process and will incur a certain maintenance cost.

Any changes without prior notice!

Version number: 2.2

HUIZHOU EPEVER TECHNOLOGY CO., LTD.

Tel: +86-752-3889706

E-mail: info@epever.com

Website: www.epever.com